

Note: Isometric drawing is for reference only, details may not accurately represent actual design - please see detailed views for technical information

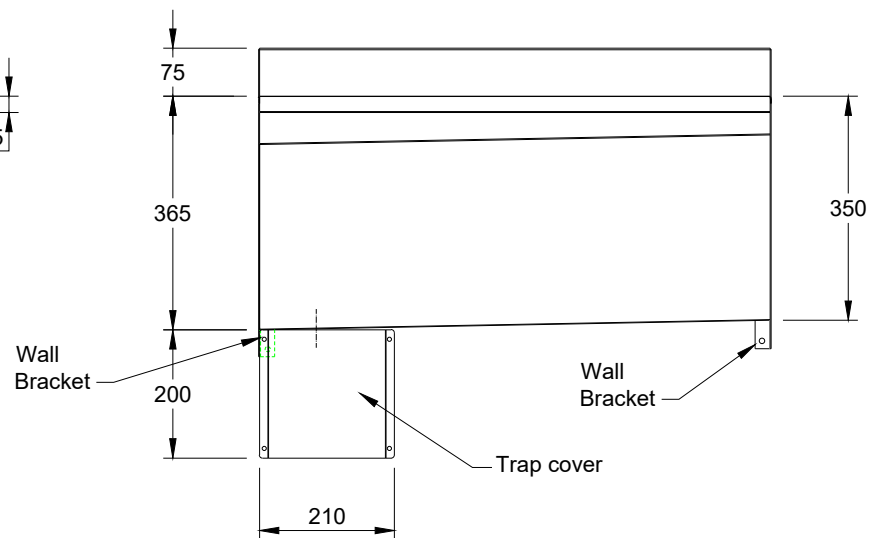
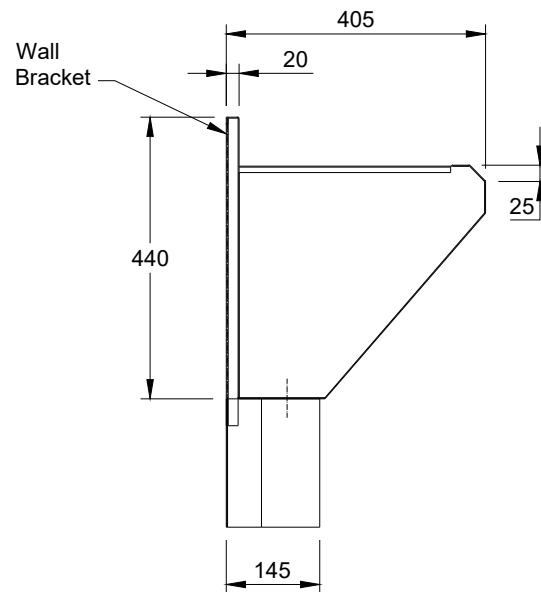
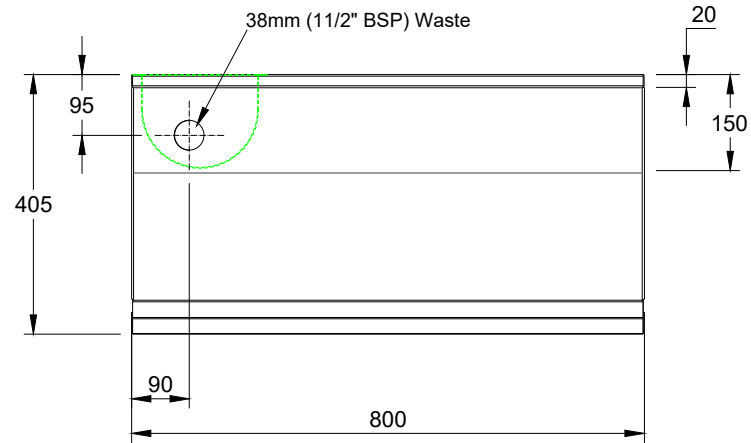
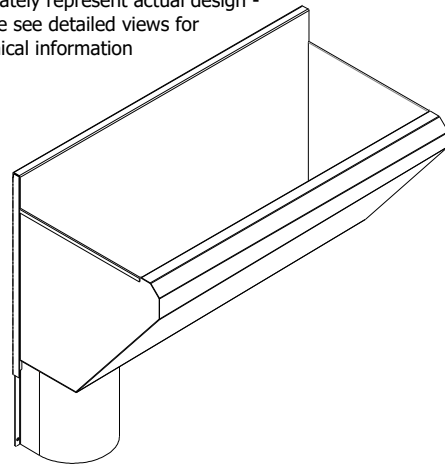

DO NOT SCALE DRAWING

A	27/06/2019	Design modified
---	------------	-----------------

TITLE: 1 User 800mm Surgeons Scrub Trough Sink - HBN 00-10 & HTM 64 - SplashBack, LH			
WEIGHT: Trough: 12.84kg & Trap Cover: 1.31kg	PRODUCT CODE: HL4008L		
MATERIAL: 1.5mm thick grade 1.430 (304) Stainless Steel in a satin finish	SCALE: NTS	PAPER: A4	DATE: 03/06/2019

NOTES:
 Drawing to: BS8888 Engineering Drawing Practice
 Welding to: BS EN 25817:1992 Quality Level B
 Tolerance unless otherwise stated to be:
 Machining: $\pm 0.75\text{mm}$. Centre distance $\pm 0.25\text{mm}$. Angles $\pm 0.30\text{mm}$
 Fabrication: Up to 600mm $\pm 0.75\text{mm}$ Over 600mm $\pm 1.5\text{mm}$. Angles $\pm 1\text{mm}$.
 Screw threads to BSI Medium Fit
 Remove all burrs and sharp edges

HEALEY & LORD
 A MAG Group Company

Website: www.hlwashrooms.co.uk
 Tel: 01603 558855
 Email: sales@hlwashrooms.co.uk
 Address: HL Washrooms, MAG Building,
 Vulcan Road South, Norwich, Norfolk, NR6 6AF